

REVISIONS			
LEVEL	DESCRIPTION	APPROVED	DATE

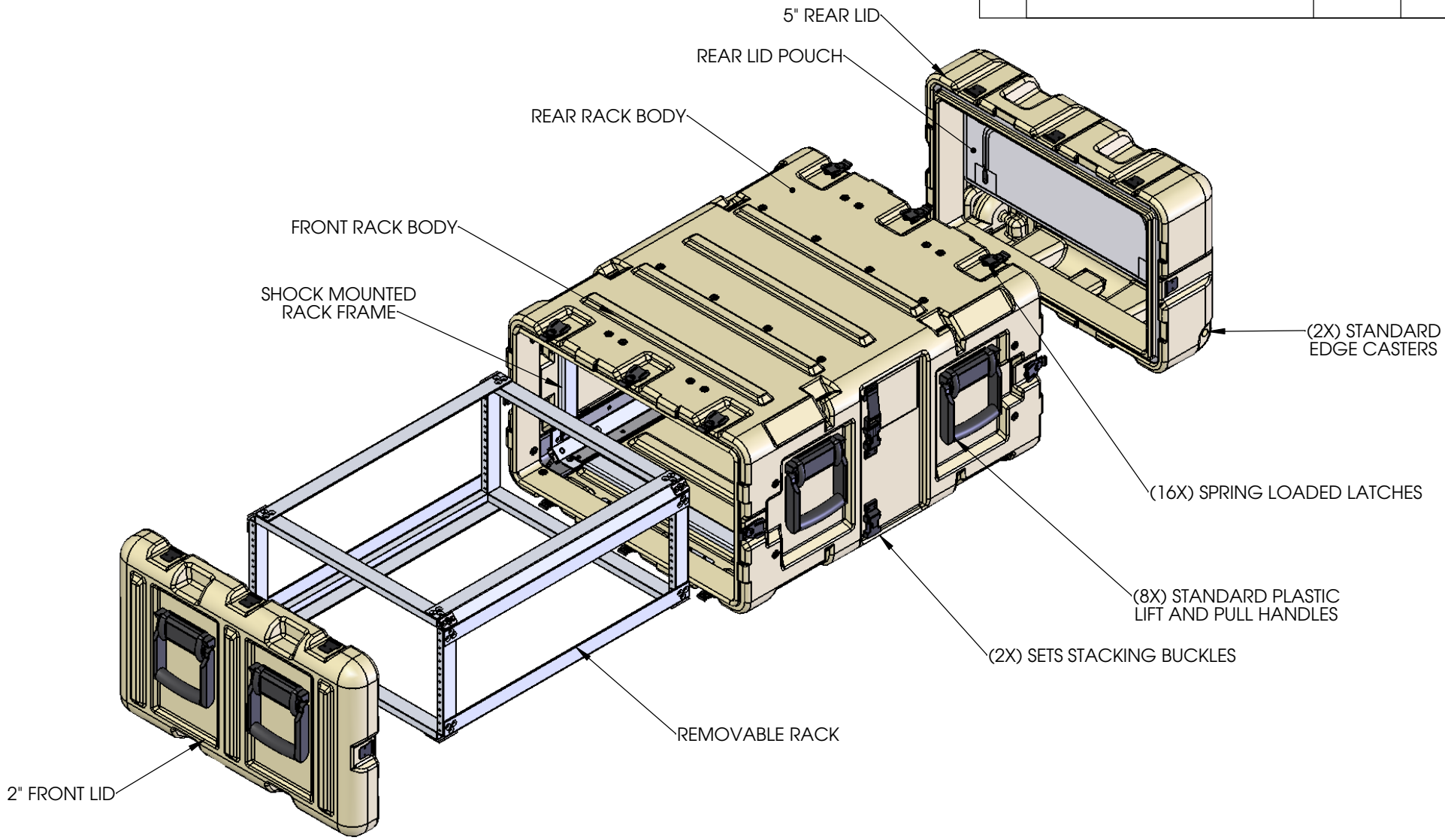

MATERIALS:	DIMENSIONAL TOLERANCES	
ROTOMOLDED HIGH DENSITY POLYETHYLENE	ALL DIMENSIONS IN INCHES UNLESS NOTED OTHERWISE	
6061 ALUMINUM RACK	00 - 06"	0.125"
	06 - 12"	0.250"
	12 - 50"	0.375"
ONE COMPLETE SET INCLUDES:	ASSEMBLY:	
ONE (1) CASE, AS SHOWN	XXXX	

NAME	DATE
DRAWN J THOMSON	01/12/12
CHECKED M SCHRAPP	
APPROVED J THOMSON	

AMERIPACK
 TITLE: EXCALIBUR SERIES
 5U X 24" RACK
 SLIDE OUT
 SHOCK RACK
 SIZE DWG. NO. REV
C AP5U-1924SO
 SCALE: N/A SHEET 1 OF 2

PROPRIETARY AND CONFIDENTIAL
 THE INFORMATION CONTAINED IN THIS DRAWING IS THE SOLE PROPERTY OF AMERIPACK. ANY REPRODUCTION IN PART OR AS A WHOLE WITHOUT THE WRITTEN PERMISSION OF AMERIPACK IS PROHIBITED.

2.58 ID
3.19 OD

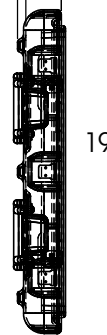

19.28

24.00

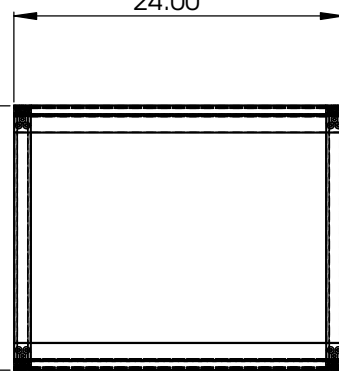

28.88

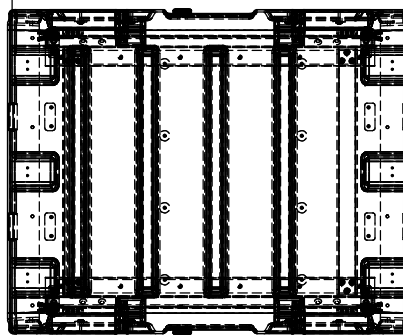

23.62

ID 5.19
OD 5.94

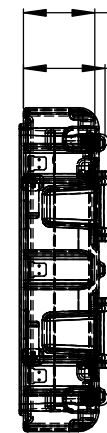

NOTES: HARDWARE, HANDLES
AND RACK FRAME
HIDDEN FOR CLARITY
OVERALL WEIGHT AS SHOWN: 63 LBS

10.44

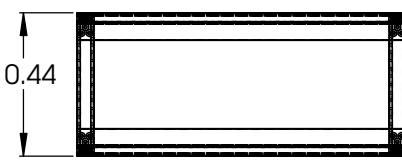
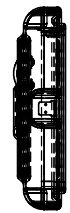

14.75
STACKING

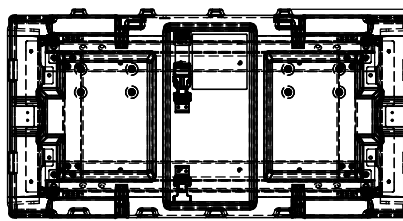

OD 15.19



MATERIALS:	DIMENSIONAL TOLERANCES				
SEE SHEET 1	ALL DIMENSIONS IN INCHES UNLESS NOTED OTHERWISE				
	00 - 06"	0.125"			
	06 - 12"	0.250"			
	12 - 50"	0.375"			
ONE COMPLETE SET INCLUDES:	ASSEMBLY:	DRAWN	J THOMSON	DATE	01/12/12
SEE SHEET 1	SEE SHEET 1	CHECKED	M SCHRAPP		
		APPROVED	J THOMSON		



TITLE: EXCALIBUR SERIES
5U X 24" RACK
SLIDE OUT
DIMENSIONS

SCALE: N/A
DWG. NO. AP5U-1924SO
REV

SHEET 2 OF 2

PROPRIETARY AND CONFIDENTIAL
THE INFORMATION CONTAINED IN THIS
DRAWING IS THE SOLE PROPERTY OF
AMERIPACK. ANY REPRODUCTION IN
PART OR AS A WHOLE WITHOUT THE
WRITTEN PERMISSION OF AMERIPACK
IS PROHIBITED.